



Owner's Manual



Dogtra Company

22912 Lockness Avenue
Torrance, CA 90501 U.S.A.

Tel) 310.534.0101

Fax) 310.534.9111

Toll free) 1.888.811.9111

Store website) shop.dogtra.com

Copyright © 2007 Dogtra Company All rights reserved. (12)

Remote Controlled Dog Training Collars

***dogtra* 1900NCP Field Star Series**



www.dogtra.com

• MAIN FEATURES	2
• PRODUCT SAFETY AND HEALTH STATEMENTS	3
• PACKAGE CONTENTS	4
• DESCRIPTION OF TRANSMITTER PARTS	5
• BUTTON FUNCTION	13
• DESCRIPTION OF RECEIVER/COLLAR PARTS	17
• BATTERY CHARGER	20
• TESTING YOUR dogtra 1900NCP Field Star Series COLLAR....	21
• FITTING THE COLLAR ON THE DOG.....	23
• CHARGING THE BATTERIES.....	26
• RECEPTION	29
• METAL BELT CLIP ACCESSORY.....	30
• ACCESSORIES.....	31
• BASIC MAINTENANCE	32
• TROUBLESHOOTING GUIDE	33
• WARRANTY AND REPAIR	36
INFORMATION	

MAIN FEATURES

- Easy-to-use, ergonomic transmitter.
- Rheostat dial allows for gradual increases in stimulation intensity with no jumps between levels (0-127).
- Two-dog models allow the trainer to control two different dogs from one transmitter.
- **dogtra 1900NCP Field Star Series** has a 1/2-mile range.
- Stimulation type - “Nick”, “Constant” and non-stimulating pager/vibration.
- Rechargeable, user-replaceable Ni-MH batteries
- Fully Waterproof receiver/collar and transmitter.
- No external antenna on the receiver/collar.
- One-charger system allows the transmitter and receiver(s) to be charged at the same time.
- Over 999 different identity codes to prevent signal match-up with other e-collars.
- Easily visible blue LCD screen displays exact level of stimulation and can be seen in the dark or low light conditions.
- Three bar battery life indicator and LED colored indicator to show remaining battery life.

PRODUCT SAFETY AND HEALTH STATEMENTS

Proper e-collar use

Dogtra e-collars are intended for the sole purpose of behavior modification of dogs. They are not intended for human use or use on other animals. Dogtra Company does not assume any liability for improper use of the Dogtra e-collar.

Aggressive dogs

Dogtra does not recommend using the e-collar to correct dogs that are aggressive towards other dogs or people. In many such cases the dog will associate the stimulation with the other dog or individual and become even more aggressive. Dog aggression is best treated by a dog-training specialist.

Interference with other electronic devices

Dogtra’s industry-leading technology filtering system ensures minimal interference with other electronic devices (garage door openers, pacemakers, etc.). Our digital microprocessor offers thousands of unique codes to eliminate frequency match-up with other Dogtra e-collars.

Inadvertent activation

If the constant button is held down for 12 seconds or more the unit will automatically shut down. It will reactivate when the button is released.

PACKAGE CONTENTS

- Transmitter
- Receiver (two receiver/collars for Dotra two-dog models)
- Battery charger and splitter cable
- Test light
- Owner's manual
- Carrying case
- Metal belt clip accessory

DESCRIPTION OF TRANSMITTER PARTS

dogtra 1900NCP Field Star transmitter (1-dog)

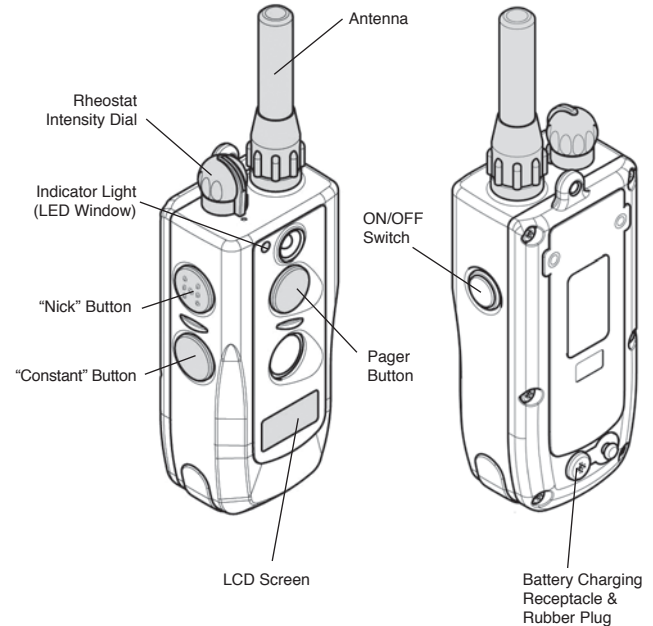

DESCRIPTION OF TRANSMITTER PARTS

dogtra 1902NCP Field Star transmitter (2-dog)

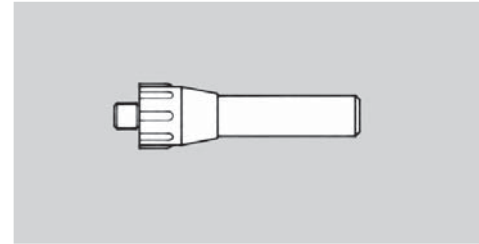
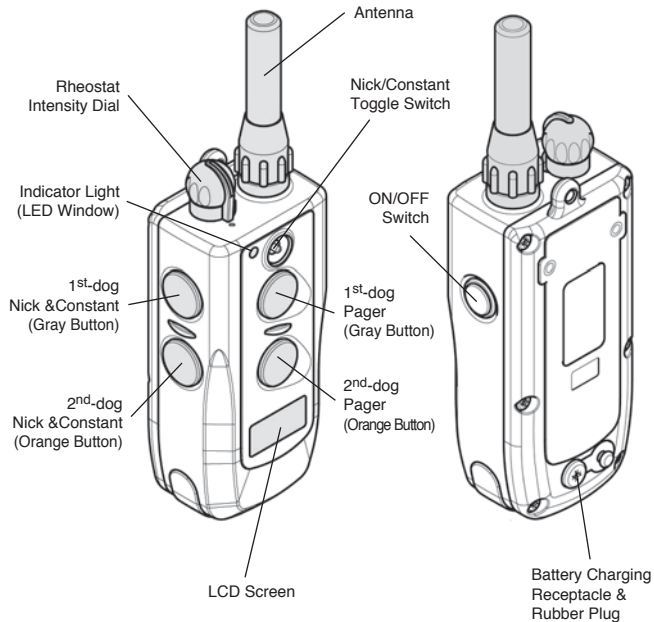

Transmitter Antenna

A short 2" antenna is supplied with the *dogtra* 1900NCP Field Star Series transmitter.

The antenna must be fastened to the transmitter before using the unit.

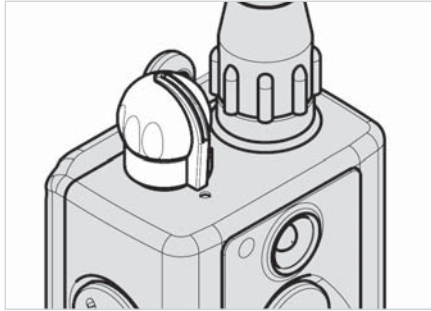

Rheostat Intensity Dial

The Rheostat Intensity Dial is located on the top of the transmitter: (0) being the lowest level and (127) being the highest. The LCD screen shows the intensity level during operation.

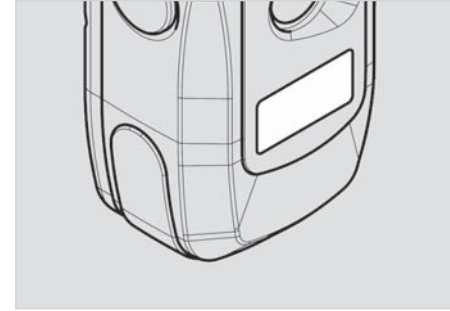

LCD Screen

The LCD screen indicates the stimulation level (0-127) on the screen.

The LCD battery life indicator shows 3 bars at full charge, 2 bars at medium charge and 1 bar when it needs to be charged. The battery life indicator only specifies the remaining charge for your transmitter. To find the remaining charge for your receiver, observe the LED on the receiver/collar.

- **Green** = full charge
- **Amber** = medium charge
- **Red** = needs charge

Care for LCD Transmitters in Cold Temperature

In cold temperatures (10 degrees F or below), the Liquid Crystal Display (LCD) on your transmitter may be dim or slow to respond. Wait until the display becomes visible before selecting any training level.

Even though the LCD screen might be dim or slow to respond, the transmitter will still function properly when you push the Nick or Constant button. In the occurrence of extremely cold weather, the LCD screen might take a moment to respond causing the intensity level to freeze at that current level. In this situation, if you turn the Rheostat Intensity Dial, and the intensity level on the screen does not increase, yet you emit an electrical stimulation, the level will be in agreement with the new changed intensity level.

In this situation, it is ideal to either wait until your transmitter is back to working order before emitting a correction, or while holding the constant button down slowly turn the Rheostat Intensity Dial while watching your dog's reaction. Do not turn the Rheostat Intensity Dial at a rapid increase because the receiver/collar will emit a static correction based on the level of the Rheostat Intensity Dial, which might not be correctly reflected on the LCD screen.

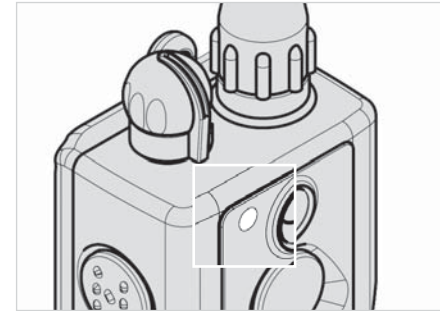

Transmitter Indicator Light (LED Window)

The transmitter LED indicator light is located near the Rheostat Intensity Dial. It will flash every 2 seconds when the transmitter has been turned on. The color of the light indicates the status of battery life. It flashes green when the battery is fully charged and turns to amber when the battery is at medium charge. It is acceptable to charge your unit even at medium charge without any damage incurred to your collar. When the transmitter indicator emits a blinking red light, the battery needs to be recharged.

(Green = full charge, **Amber** = medium charge,
Red = needs charge)

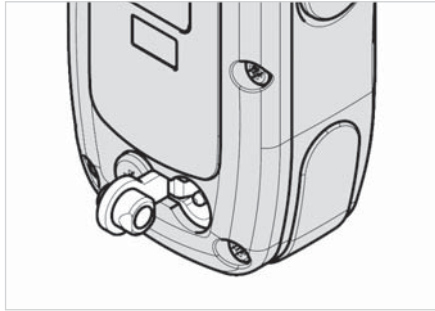

Transmitter Battery Charging Receptacle & Rubber Plug

Located on the backside of the transmitter, the charging receptacle is covered by a rubber plug. Insert one end of the battery charging cable into the receptacle to charge the battery (See Battery Charging Procedure on page 27).

After charging is completed, close the receptacle with its rubber plug to make sure dirt or water does not get inside.

BUTTON FUNCTION

dogtra 1900NCP Field Star (1-dog)

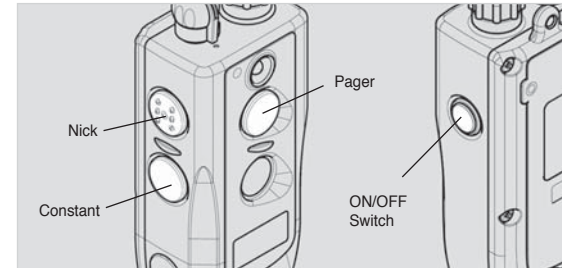

The transmitter for the *dogtra* 1900NCP Field Star single dog unit has four buttons (one on the face of the transmitter, two on the left side and one on the right side).

“Nick” Button

The “Nick” button is located on the top left. It is imprinted with the letter “N” for an easy, clear selection. When the “Nick” button is pushed the receiver emits a single, rapid pulse of electrical stimulation.

“Constant” Button

The “Constant” button is located on the bottom left. Pressing the “Constant” button gives continuous stimulation as long as the button is pushed, for up to 12 seconds. If the button is not released after 12 seconds, the stimulation will automatically turn off as a safety feature. The collar will be ready to be reactivated once the button has been released.

“Pager” Button

The “Pager” button is located on the face of the transmitter. Pressing it will give non-stimulating vibration as long as the button is depressed, for up to 12 seconds.

Transmitter Power ON/OFF

The button on the right side of the transmitter is the “ON/OFF” button that activates the transmitter and LCD screen only.

To turn the transmitter on, press the “ON/OFF” button on the right side until the LCD screen illuminates.

To turn the transmitter off, press the “ON/OFF” button on the right side of the transmitter. When the LCD screen displays “OFF” release the button.

***dogtra* 1902NCP Field Star (2-dog)**

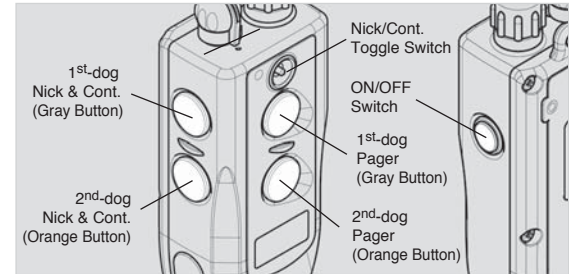

The ***dogtra* 1902NCP Field Star** two-dog unit has five buttons and a toggle switch on the transmitter (two on the face of the transmitter, two on the left side, and one on the right side.).

“Nick” & “Constant” Toggle Switch

Located on the face of the transmitter is a toggle switch. The toggle switch has a setting for “Nick” and another for “Constant”. The color-coordinated buttons (orange for the orange receiver/collar and gray for the black receiver/collar) will implement the desired stimulation based on the toggle switch setting.

When either the orange or gray stimulation button is pressed and the toggle is set on “Nick” the receiver emits a single, rapid pulse of electrical stimulation.

When you press either the orange or gray stimulation button, and the toggle is set on “Constant”, the receiver emits a continuous stimulation as long as the button is pushed, for up to 12 seconds to the corresponding collar. If the button is not released after 12 seconds, the stimulation will automatically turn off as a safety feature. The collar will be ready to be reactivated once the button has been released.

“Pager” Button

The “Pager” buttons are located on the face of the transmitter. The orange button corresponds with the orange receiver/collar and the gray with the black receiver/collar. Pressing it will give non-stimulating vibration as long as the button is depressed, for up to 12 seconds.

DESCRIPTION OF RECEIVER / COLLAR PARTS

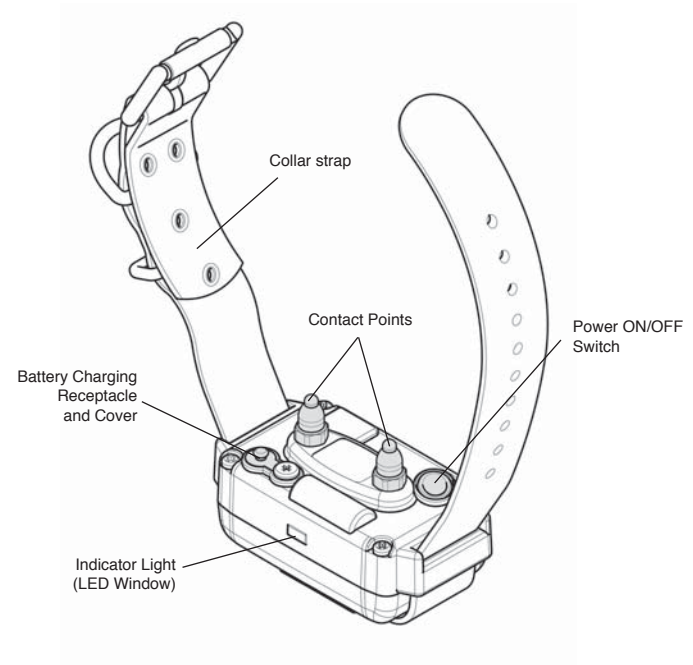

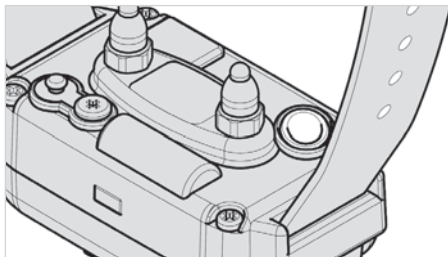

Turning on the Receiver / Collar

The ON/OFF button is on the bottom of the receivers. Push and hold the button for two seconds until the LED light, located on the front of the collar, starts blinking. The indicator light will blink once every 2 seconds after the collar is turned on. The color of the light indicates the status of battery life. The LED glows green when the battery is fully charged and turns to amber when battery life is getting low. When the LED emits a blinking red light, the battery needs to be recharged.

(**Green** = full charge, **Amber** = medium charge, **Red** = needs charge)

When the "Constant" button on the transmitter is pushed, the collar indicator light will glow steadily as long as you hold the button down, for up to twelve seconds. When the "Nick" button is pushed, the light comes on for a fraction of a second.

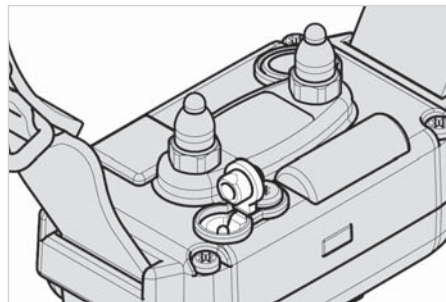

Receiver Battery Charging Receptacle & Rubber Plug

On the inside of the receiver/collar, next to the collar strap, is a battery-charging receptacle with a rubber plug.

Internal Antenna

All Dogtra E-collars have non-exposed antennas that are located inside the receiver/collar.

BATTERY CHARGER

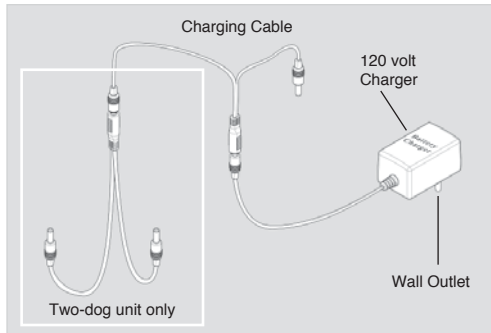

The battery charger and charging cables allow you to charge both the transmitter and receiver at the same time. The battery charger is designed for a 120-volt wall outlet (European 230-volt AC chargers and 12-volt field charger for your automobile are also available.).

To use the battery charger for the two-dog unit, combine both sets of battery charging (splitter) cables as shown. This enables you to charge the transmitter and both receivers at the same time.

Note : Only use Dogtra-approved Chargers for your Dogtra e-collar. This will prevent any damage that can be incurred from attempting to use a different charger.

TESTING YOUR *dogtra* 1900NCP Field Star Series COLLAR

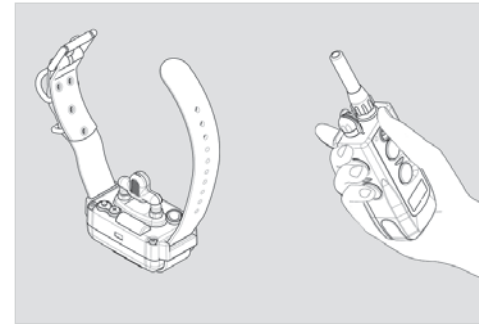

1. Turn the receiver/collar on by pressing the ON/OFF button on the receiver. The indicator light will come on for a moment then blink once every 2 seconds, showing that the collar is ready to use (If the indicator light is red, or if there is only 1 bar showing on the battery icon on the LCD transmitter screen, the unit needs to be charged.).
2. Place the test light included in the package contents on the contact points as shown in the diagram.

3. Turn the transmitter on by pressing the blue button on the right side of the transmitter until the LCD screen illuminates. The LCD screen shows the amount of battery life remaining and the LED blinks once every 2 seconds.
4. Watch the test light as you push the “Nick” button on the transmitter. It should light for just a moment.
5. Watch the test light as you push the “Constant” button on the transmitter. It should light for as long as the button is pressed. However, as a safety feature, the receiver/collar will automatically shut off stimulation if the constant button is depressed for 12 seconds or longer.
6. Turn the Rheostat Intensity Dial on the transmitter clockwise and then counterclockwise. The test light should glow brighter with higher levels of stimulation and dimmer with lower levels. When you change the intensity dial, the number on the LCD screen will change as well.
7. Pressing the “Pager” button on the front of the transmitter causes the collar to vibrate for up to 12 seconds. The collar will reactivate when you push the button again.

Note : The test light may not luminate if the intensity level is set below level ten.

FITTING THE COLLAR ON THE DOG

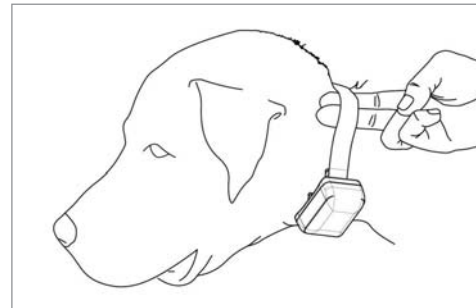

PROPER FIT

The collar should be fitted so that the surgical stainless steel contact points press firmly against the dog's skin. You should be able to fit a finger in between the contact point and your dog's skin. The best location is either side of the dog's windpipe.

IMPROPER FIT

A loose fit can allow the collar to move around on the dog's neck. When this happens, the contact points may rub against the skin and cause irritation. If the collar is too loose, electrical contact will be inconsistent causing your corrections to be inconsistent.

Dogtra uses surgical stainless steel contact points and anti-microbial plastic to protect the dog's skin.

ATTENTION!

Avoid having the dog wear the collar for more than 8 hours out of every 24-hour period. Leaving the points on the same spot for extended periods of time can cause skin irritation. If the dog is to wear the e-collar for long periods, occasionally reposition the collar so that the contact points are moved to a different location on the dog's neck.

INTENSITY SELECTION

The *dogtra 1900NCP Field Star Series* has a Rheostat Intensity Dial on the top of the transmitter (0 is the lowest and 127 is the highest). Remember that you will need to adjust the setting (upward or downward) depending on your dog's temperament and threshold for stimulation. Also, as the dog's attitude changes, especially during times of increased excitement or distraction, you may need to adjust the intensity level.

Note : The stimulation intensity can be adjusted even while the stimulation is in use.

CHARGING THE BATTERIES

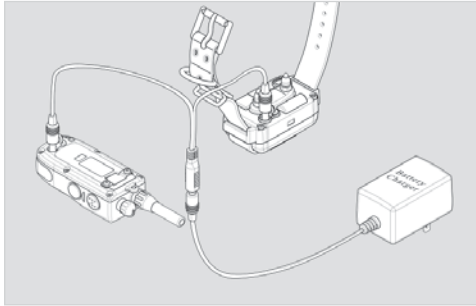

dogtra 1900NCP Field Star Series uses Ni-MH (Nickel-Metal-Hydride) batteries.

1. Charge the unit before using the unit for the first time.
2. Do not charge the batteries near any flammable substances.
3. Fully charge the batteries for 10 hours if the unit is to be stored without use for a period of 3 months or more.

Recharge the unit if :

- The LED indicator light on the receiver/collar is emitting a red color.
- If the 3 bar indicator on the transmitter LCD shows just 1 bar.
- The indicator light on the transmitter or receiver will not come on.
- The indicator light on the transmitter or receiver comes on momentarily, but will not stay on when the “Constant” button is pushed.

Battery Charging Procedure

1. Attach the charging cables to both the transmitter and receiver(s), as shown on page 26.
2. Plug the charger into a 120-volt wall outlet or, if using the accessory field charger, plug into a cigarette lighter (Use a 230-volt European charger for Europe.). When properly plugged in, all indicator lights should glow red.
The receiver automatically turns off when you insert the charging cable into the battery-charging receptacle on the receiver.

3. After charging, cover the battery charging receptacles with the rubber plugs on the transmitter and receiver.
4. The battery is fully charged with a 10-hour charge. The lights will stay red during the charging process. They DO NOT turn green when fully charged. Charging the batteries for more than 10 hours at one time will not extend battery life.

RECEPTION

The **dogtra 1900NCP Field Star Series** collar has a range of 1/2-mile. Depending on the way you use your transmitter, the range may vary.

Hold the transmitter away from your body and avoid touching the antenna, to get the greatest range.

For maximum signal strength, keep your unit properly charged.



Maximum Range



Typical Range



Minimum Range

METAL BELT CLIP ACCESSORY

To attach the metal belt clip to your transmitter, follow the steps below.

The final result should look like step 2.

Step. 1.

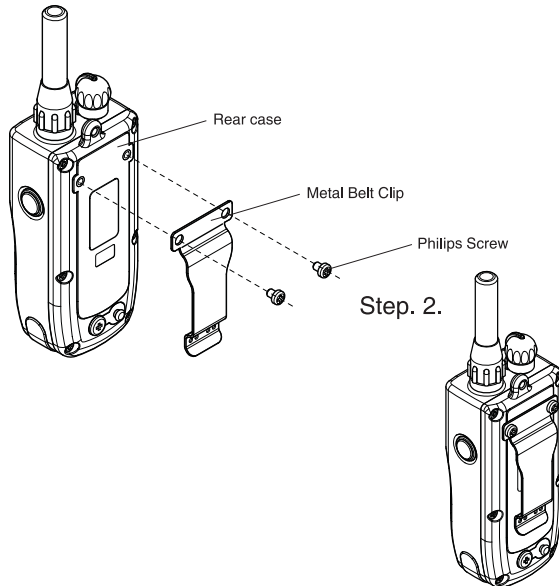

ACCESSORIES

The following items may be purchased separately by calling our customer service at (888) 811-9111. You may also browse the selection at shop.dogtra.com.

European Charger

Designed for use with 230V AC electrical outlets in Europe.

Field Auto Charger

Designed for use with the 12-volt cigarette lighter in your car.

BASIC MAINTENANCE

Be sure that the rubber charging plugs are always secured when the collar is in use. If your plugs break or are ripped, please contact Customer Service at info@dogtra.com or (888) 811-9111 to obtain replacements.

After each session, carefully inspect your unit for any missing parts, or casing damage. Broken casings on either the receiver or transmitter may affect the waterproof guarantee of the unit. The transmitter antenna should be secured and tight for optimum performance. Rinse the unit after each session and clean off any dirt or debris.

Storage Maintenance

Your unit should be fully charged for 10 hours before extended storage. During storage, the unit should be charged every 3 months for 10 hours, and once before the first use.

When traveling, try to store your units in room or slightly warmer temperatures, do not transport the unit exposed in extreme climates.

Troubleshooting:

If you suspect your unit is malfunctioning please refer to the “Troubleshooting Guide” before you send your unit in for service.

If you have any questions or concerns, you may direct your inquiries to info@dogtra.com or call (888) 811-9111.

TROUBLESHOOTING GUIDE

1. My dog is not reacting to the collar.

- Make sure the receiver is turned on. Push and hold the ON/OFF button on the receiver for two seconds until the LED light starts blinking. Push the blue button on the transmitter until it illuminates to activate the transmitter.
- Be sure the collar strap is tight enough so both contact points are touching the dog’s skin.
- The contact points may be too short for the dog. To place an order for longer contacts appropriate for your dog, please call (888) 811-9111. If you are already using the longest contact point available, you might need to trim down the hair on the dog’s neck so both contact points are touching the dog’s skin.
- The intensity level may be too low for your dog. Keep increasing the stimulation until the dog responds usually by neck movement, head shaking, looking over his shoulder, etc. (response may be very subtle so pay attention.)

2. The LED indicator light comes on, but I do not feel any stimulation.

- Your tolerance may be higher than your dog's. You may need to try the unit on your fingertips where sensitivity is higher and/or increase the stimulation level. Be sure both contact points are touching both of your fingertips.
- The battery may be low, check the LED light for battery life.
- If you have a full charge, and you have done all of the above, your unit may need to be serviced. Please contact Customer Service at info@dogtra.com or (888) 811-9111.

3. The transmitter has no range, or stimulation is less when the dog is farther away.

- The antenna(s) may be damaged. To order parts, please contact Customer Service at (888) 811-9111.
- The range indicated on the unit's box is for flat terrain. Heavy brush, trees, hills or moisture will affect the range of your unit. For best range, hold the transmitter vertically above your head, and/or try moving to higher ground.
- Any electrical conductors will affect the range, such as cars, chain-link dog runs, metal buildings and radio towers. For best results, operate away from these structures.

4. My collars are not holding a charge.

- The batteries might not be charged properly, or the charger, splitter and the charging port needs to be looked at. If you suspect your charger/splitter is not functioning properly please contact Customer Service at info@dogtra.com or (888) 811-9111. You can send in your charging units to have us inspect them.
- The charging pin may be damaged. Inside the charging port, there is a metal pin that should be standing straight up and stiff. If the pin is wobbling, broken or missing, you will need to send the unit in to the Repair Dept. The charging port must be clean prior to charging, clean the dirt out with a cotton swab and some rubbing alcohol. If the dog is in salt-water, be sure to rinse the receiver and charging port with clean water.
- For Dogtra units over two years old from the purchase date, the batteries may be replaced. You can replace them yourself by contacting Dogtra. Damages incurred to the unit due to improper battery installation are not covered under any warranty. Battery replacement is the only time customers should open the unit, any other unauthorized servicing or tampering with the unit voids your limited lifetime warranty. If you are still having problems after replacing the batteries, Dogtra strongly recommends sending the unit in for inspection.

WARRANTY AND REPAIR INFORMATION

2-Year Limited Lifetime Warranty

Dogtra Company provides the original purchaser with a 2-YEAR WARRANTY for the 175NCP, 180NCP, 200NCP Gold/C Series, 210NCP Series, 280NCP/C Series, 300M Series, 1400NCP Series, 1500NCP Series, 1600NCP Series, 1700NCP Series, 1800NC Series, 1900NCP/S Series, 2000T&B Series, 2200NCP Series, 2300NCP Series, 2500T&B Series, 3500NCP Series, SureStim Series, ARC Series, and the EDGE RT.

The warranty begins from the date of purchase. For the first two years, coverage is for both Parts and Labor on warranty repair services. Accessories such as chargers, splitter cables, antennas, straps, and batteries are covered for the first year only. After the first two years, the Limited Lifetime Warranty covers Parts only and does not cover Labor Fees and Accessories. All Shipping fees incurred, the cost of Accessories after the first year, and Labor fees associated with out of warranty repair work, are the customer's responsibility. Labor fees will be variable depending on the extent of the work required. The Limited Lifetime Warranty expires 5 years after a model is discontinued from production by Dogtra.

To Qualify for the Dogtra Warranty

All products must be registered and/or a proof of purchase is required to initiate repair work under warranty. To register your Dogtra product, log onto our website at www.dogtra.com, click on the warranty registration link, and fill out the required information. Registration must be completed within 30 days of purchase. If you do not have access to a computer, you can call our toll free number at 1-888-811-9111, and one of our customer service representatives will register the product for you. If you were unable to register your product within 30 days of purchase, we will accept all products for repair with a proof of purchase. We strongly recommend keeping the original receipt. If your product is not registered and a proof of purchase is not available at the time of service, Dogtra will estimate the

age of the unit by the serial number. Serial number estimates can differ from the actual purchase date. A serial number estimate is the only method of determining an approximate date of purchase without product registration or a proof of purchase.

Not Covered Under Warranty

Dogtra DOES NOT offer warranty for products that have been bought secondhand or as a resold product.

Dogtra DOES NOT replace defective units or provide refunds for products purchased from us after 30 days from the date of purchase.

Dogtra DOES NOT cover the cost of shipping outside of the Continental United States.

Issues of replacement and refunds on units purchased less than 30 days from an authorized dealer must be addressed to the dealer directly. If the products purchased from an authorized dealer are after 30 days from the date of purchase, please send the units to Dogtra for service and repair.

Dogtra DOES NOT cover the cost of repairs and replacements due to misuse by the owner or dog, improper maintenance, and/or lost units. Any water damage on the Water Resistant Transmitters of the 175NCP, 180NCP, 200NCP Series, 1400NCP Series, 1500NCP Series, and iQ Pet Series, and the Water Resistant Receivers of the RRS, RRD, and RR Deluxe, will not be covered. All replacement costs for either the transmitter or receiver will be the owner's responsibility.

The warranty is void if the unit has been altered or an unauthorized person has damaged the unit while attempting repair work.

Battery replacement by the customer during the first year of the 2-year Limited Lifetime Warranty is not recommended. If the customer chooses to replace the batteries, any damage to the unit during the change-out by the owner will void the warranty.

The removal of serial numbers from any Dogtra products will void the warranty.

Dogtra reserves the right to retain and discard any parts or accessories that have been found damaged upon replacement and repair.

WARRANTY AND REPAIR INFORMATION

Procedure for Repair Work

If the unit is malfunctioning, please refer to the “Troubleshooting Guide” in the Owner’s Manual and call customer service at 1-888-811-9111, for technical support, before sending it to Dogtra for Service.

The cost of shipping products under warranty back to Dogtra is the customer’s responsibility. Dogtra is not responsible for units damaged or lost in transition to Dogtra. Dogtra is not responsible for loss of training time or inconvenience while the unit is in for repair work. Dogtra does not provide loaner units or any form of compensation during the repair period. A copy of the sales receipt showing the purchase date may be required before warranty work is initiated.

Please include a brief explanation outlining the problem and include your name, address, city/state/zip code, daytime phone number, evening phone number, and email address. Or you can visit our website at www.dogtra.com for a service request form. If the repair costs are not covered under warranty, we will call you for payment information and authorization. For any questions concerning your Dogtra products, call us toll free at 1-888-811-9111, M-F 8:30AM - 4:00PM, Pacific Standard Time, or email us at repair@dogtra.com for specific repair inquiries.

Send repair units to :

Dogtra Company / Repairs
22912 Lockness Avenue
Torrance, CA 90501
U.S.A.

The diagrams and representations in the manual may differ slightly from the actual product depending on the model type.