

# **E-FENCE 3500**

UNDERGROUND E-FENCE SYSTEM

## **Owner's Manual**

Please read this manual thoroughly  
before operating the Dogtra E-FENCE 3500.

# CONTENTS

OVERVIEW .....	3
MAIN FEATURES OF THE E-FENCE 3500 .....	4
SAFETY FEATURES .....	4
PACKAGE CONTENTS .....	5
DESCRIPTION OF TRANSMITTER PARTS .....	6
DESCRIPTION OF RECEIVER PARTS .....	10
RECEIVER FITTING .....	12
ADAPTOR .....	13
CHARGING THE RECEIVER .....	14
CHANGING THE CONTACT POINT LENGTH .....	15
TESTING THE SYSTEM PRIOR TO INSTALLATION .....	16
INSTALLATION .....	17
WIRE SPLICING .....	23
OPTIONAL ACCESSORIES .....	25
TROUBLESHOOTING GUIDE .....	27
GENERAL MAINTENANCE TIPS .....	29
WARRANTY AND REPAIR INFORMATION .....	30

## **OVERVIEW**

The Dogtra E-FENCE 3500 system gives you the ability to allow your dog the freedom he wants within your specified boundaries. Dogtra's containment system contains your dog without the use of conventional fencing that can be chewed through, jumped over or dug under.

The width of the signal field can easily be adjusted at the wall-mount transmitter. The strength of the electrical stimulation can be adjusted on each separate receiver with the Stimulation Selection Dial. In the "Pager/Stimulation" mode, your dog will receive a Pager vibration, followed by stimulation when he approaches the boundary area. In the "Pager Only" mode, your dog will receive a Pager vibration only.

Accessories for the system such as additional wire, flags, lightning/surge protector, and the European 220-volt battery charger are available by calling Dogtra Company at (888) 811-9111.

## **MAIN FEATURES OF THE E-FENCE 3500**

- Wide range of stimulation for all breeds and temperaments
- Fully waterproof receiver
- 8 intensity levels on the receiver to control individual dog stimulation needs
- HPP (High Performance Pager) vibration warning before stimulation
- HPP (High Performance Pager) vibration only mode
- Wire breakage light with audible warning tone
- Long range signal with 40 acres maximum area coverage
- Advanced filtering system to prevent interference from outside sources
- Expandable to multiple dogs
- 2-hour rapid charge lithium polymer batteries

## **SAFETY FEATURES**

- Dogtra's E-FENCE 3500 system uses state-of-the-art microcomputer technology. The receiver has an automatic control that limits the stimulation to eight seconds.
- Dogtra's filtering system prevents accidental activation from outside sources other than your transmitter.

# PACKAGE CONTENTS



Wall-Mount  
Transmitter



Receiver



20ga Underground  
Fence Wire (500 feet)



Boundary Training  
Flags (50 each bundle)



Owner's  
Manual



Training  
Book



Transmitter  
Power Adaptor  
(24-volt 500mA)



Receiver  
Charger (5-volt 1A)



Ground Wire  
(green)



Test Lamp



Plastic Anchors  
(2 ea.)



Transmitter  
Mounting  
Screws (2 ea.)



Wire Splices  
(4 ea.)



Enhanced  
Contact Points  
Male (2 ea.)



Plastic Contact  
Points (2 ea.)



Contact Point  
Extension Washer &  
Adjustment Tool

# DESCRIPTION OF TRANSMITTER PARTS

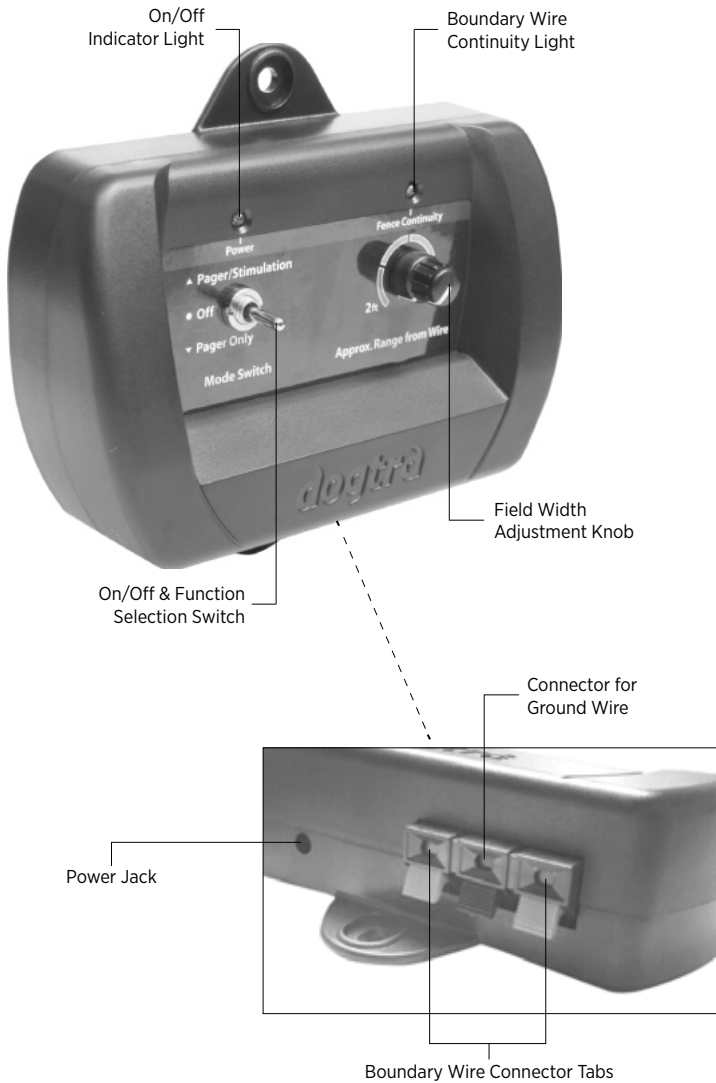

**E-FENCE 3500  
Transmitter**

### On/Off & Function Selection Switch



The On/Off & Function Selection Switch has three functions. When the toggle switch is in the up position, the unit will give the dog a Pager vibration followed by stimulation. When the toggle switch is in the down position, only a Pager vibration occurs (no stimulation). The power is off when the toggle switch is set to the middle position.

### Field Width Adjustment Knob



This knob controls the width of the signal field (the approximate distance from the boundary wire to the location where the receiver first activates). Turning the knob clockwise increases the field width, giving your dog a wider area before the activation begins. Turning it counter-clockwise decreases the signal field, thus giving the dog a shorter area prior to activation.

### On/Off Indicator Light



When the On/Off & Function Selection Switch is either in the up or down position the on/off indicator light will be on, indicating that the power is on. When the switch is in the middle position the light goes off, indicating that the power is off. The indicator light stays on even if a fuse is blown.

### Boundary Wire Continuity Light



When the wires are connected properly, the boundary wire continuity light will be on. In the event that the E-FENCE 3500 wire becomes damaged or disconnected, the light will automatically turn off and the warning beep will sound.

### Wire Connector Tabs

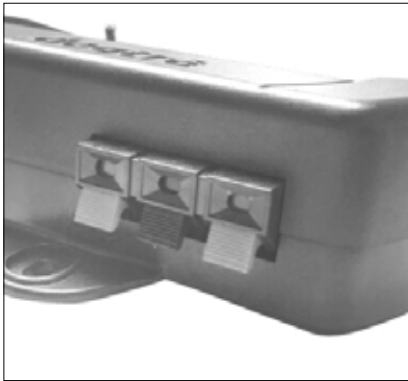

The easy-to-use push-release wire connectors let you instantly connect or disconnect the boundary wire leads. Wires should have the plastic coating stripped approximately a half-inch before being inserted into the red connectors on the bottom of the wall mount transmitter. The system comes with a ground wire to ground the unit. Strip about a half-inch on each end of the ground wire and insert one end into the black connector on the bottom of the wall transmitter. The other end

should be buried into the ground or wrapped around a water pipe and secured with electrical tape.

**Option:** A lightning/surge protector can be purchased if there are no grounding options near the wall transmitter.



## Power Jack

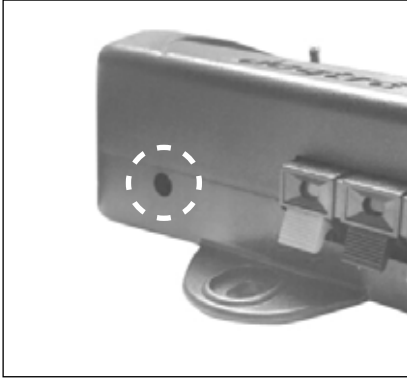

Plug the 120-volt adaptor into a 120-volt wall outlet and insert the adaptor plug into the power jack of the transmitter.

## Wall-Mount Transmitter



Use the (2) included screws to mount the transmitter to a wall securely near an outlet. The unit will withstand freezing temperatures, **but it is not waterproof**. Therefore, we recommend mounting the transmitter in a safe, dry sheltered area such as a shed, garage or carport. Plastic anchors have been provided to secure mounting onto drywall. Use a 1/4" drill bit to make holes into the drywall. Insert the anchors into the holes so that the open end faces out and mount the transmitter by inserting the screws into the open end of the anchors. To power the wall transmitter, plug the power adaptor into a standard 120-volt outlet and connect it to the power jack of the transmitter.

# DESCRIPTION OF RECEIVER PARTS

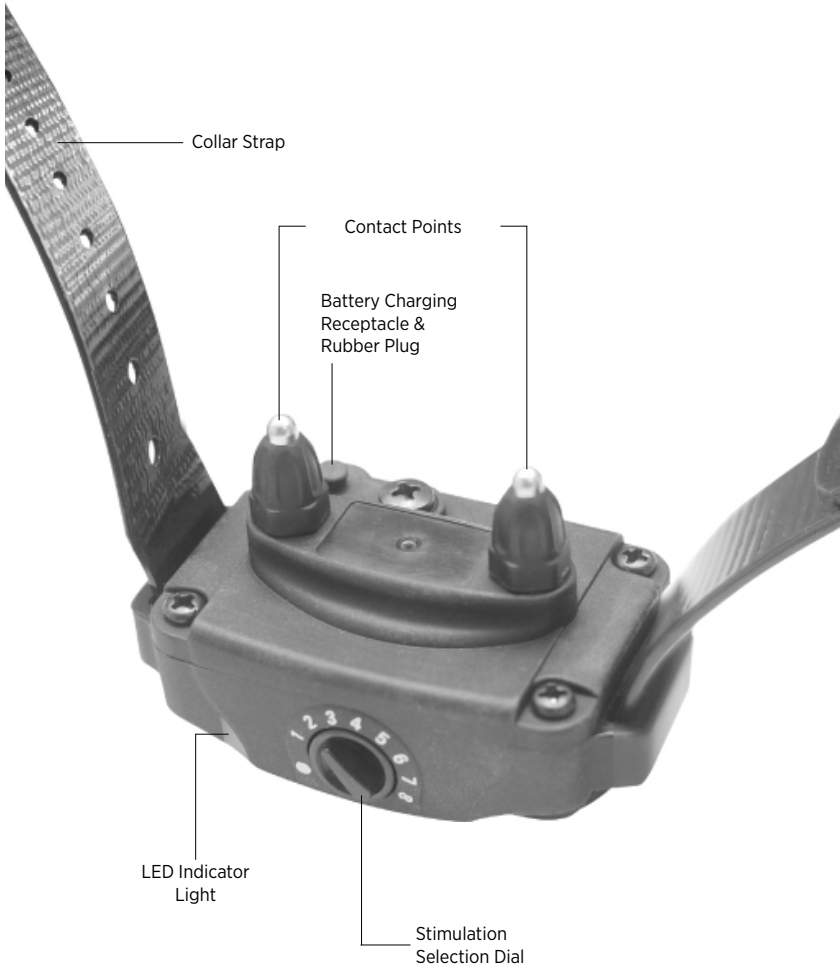

**E-FENCE 3500**  
**Receiver**

## Stimulation Selection Dial

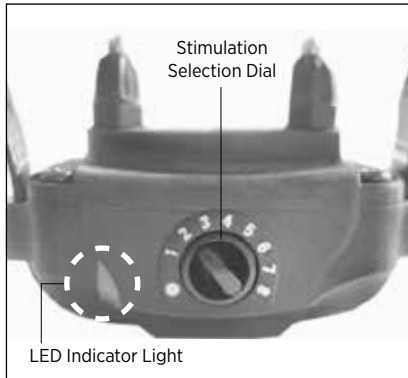

The stimulation level is adjustable from each individual dog's receiver so that it is easy to accommodate to each dog's different personality and temperament. The stimulation levels range from level 1 to level 8 (1 being the lowest and 8 being the highest). In order to select the proper stimulation level for each dog, we recommend that you begin at level 1 and continue to increase the level slowly until you are able to notice a reaction from your dog. This ensures that you select a level that is appropriate for

your dog. When you place the knob at the "0" position, the receiver is completely shut off. In order to maintain full use of the batteries in the receiver, please turn off the receiver when your E-FENCE 3500 system is not being utilized.

## Receiver LED Indicator Light

When first activating the E-FENCE 3500, the LED light on the receiver will illuminate for approximately 1 second to indicate that the power is on. Once the unit is turned on, a blink will occur every 2 seconds to indicate that the receiver is functioning properly. The color of the LED indicates the battery life of the receiver.

**Green = Full charge**

**Amber = Medium charge**

**Red = Needs charge**

When the receiver does not receive a signal from the transmitter for 10 seconds or more, the receiver will go into sleep mode, and the LED light will stop blinking.

When your dog gets close to the e-fence boundary wire, the indicator light will blink steadily to indicate that the receiver is being activated.

## Battery Charging Receptacle & Rubber Plug



On the inside of the receiver next to the collar strap is a battery charging receptacle and rubber plug.

The unit will be fully waterproof with or without the rubber plug. If the dog was in salt water, make sure to rinse the receiver and charging port with clean water and air dry.

# RECEIVER FITTING

## Proper Fit

The receiver should be fitted so that the medical grade stainless steel contact points press firmly against the dog's skin. You should be able to fit two fingers underneath the collar strap. The best location is on either side of the dog's windpipe.

## Improper Fit

A loose fit can allow the receiver to move around on the dog's neck. When this happens, the contact points may rub against the skin and cause irritation. If the receiver is too loose, the contact will not be consistent and cause the corrections to be inconsistent. Dogtra uses medical grade stainless steel contact points and anti-microbial plastic to protect the dog's skin.

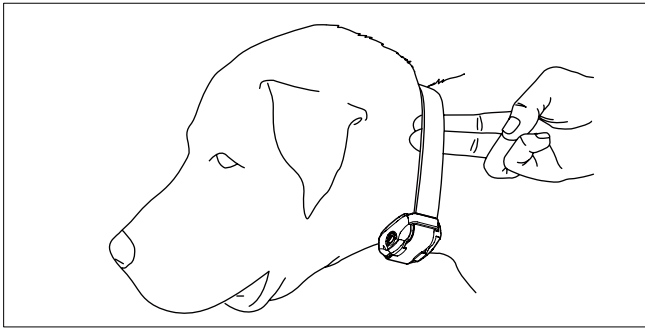

### **Attention!**

Leaving the receiver in the same location on the dog's neck for an extended period of time can cause skin irritation due to the sensitivity from the contact points. If the dog is to wear the receiver for long periods, occasionally reposition the receiver every few hours so that the contact points are moved to a different location on the dog's neck and remove the receiver after 8 hours of usage. Make sure you check for skin irritation each time you use the unit.

# ADAPTOR

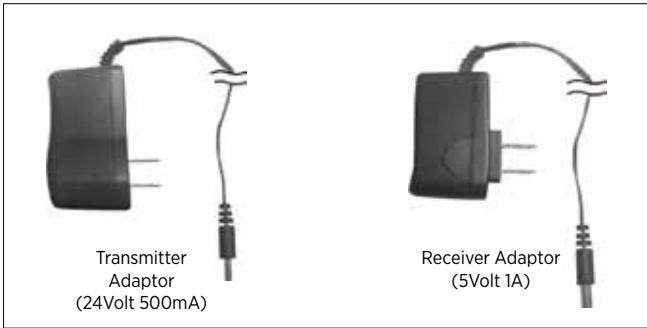

The battery charger is designed for a 120-volt wall outlet.

## CHARGING THE RECEIVER

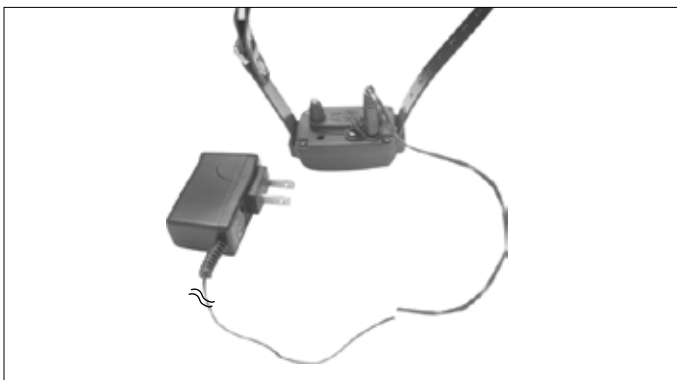

The Dogtra E-FENCE 3500 receiver uses a lithium polymer battery. Recharge the unit if the indicator light is red or does not come on.

**NOTE 1:** Only use Dogtra-approved batteries, chargers, and accessories for your Dogtra e-collars. This will prevent any damage that can be incurred from attempting to use a different charger.

**NOTE 2:** The unit has a partial charge when it leaves the Dogtra facility. Upon receipt of the system, be sure to give it a full 2-hour initial charge before the first use away from any flammable substances.

**NOTE 3:** When a charger is not in use, disconnect it from the power source. Fully charge the batteries if the unit is to be stored without use for a period of 3 months or more.

### **Follow the steps below to charge your system:**

1. Open the rubber plug on the battery charging receptacle and plug in the charging cable.
2. Plug the charger into a 120-volt wall outlet or, if using the auto charger, plug into a cigarette lighter only for lithium polymer batteries (use a 220 volt European charger for Europe). All indicator lights should glow red when properly plugged in and the unit will automatically shut off during the charging process. You will need to turn the unit on again before use once the unit is fully charged and unplugged from the battery cable.
3. The lithium polymer battery is fully charged within 2 hours. The lights will stay red during the charging process and turn green once the unit is fully charged.
4. After charging, cover the battery charging receptacle with the rubber plug.

## CHANGING THE CONTACT POINT LENGTH

The Dogtra E-FENCE 3500 comes equipped with standard 5/8" contact points that can be extended to 3/4" contact points, for use with dogs with longer coats. To increase the contact point length from 5/8" to 3/4", follow the steps below.

1. Using the included adjustment tool with the side marked 5/8", unscrew the contact points counter-clockwise.
2. Place the contact point extension over the exposed threads, flat side down.
3. Place the contact points over the extensions and tighten the contact points and extensions clockwise using the adjustment tool with the side marked 3/4".

**Caution:** Tighten until firmly in place. Be careful not to over tighten.

To shorten the contact points back to the standard 5/8", start with the adjustment tool with the side marked 3/4", remove the contact point extensions, and tighten the contact points with the adjustment tool with the side marked 5/8".

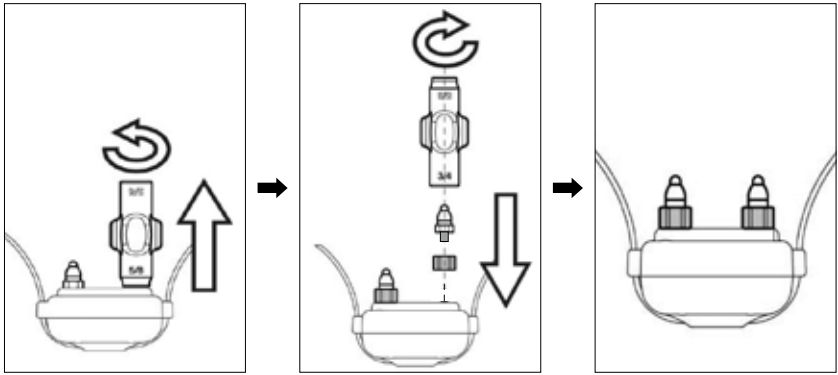

## TESTING YOUR SYSTEM PRIOR TO INSTALLATION

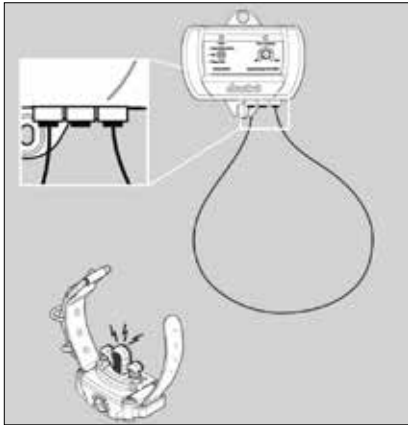

1. To ensure that your E-FENCE 3500 system is working properly, connect the power adaptor into the transmitter power jack and then plug the power adaptor into a household outlet. Switch the stimulation knob to Pager/Stimulation or Pager Only. The on/off indicator light should turn on.

2. Unwind the length of ground wire that was provided and strip about 1/2 inch off each end. Insert both ends of the ground wire into the outer red wire connector jacks, leaving the center jack free. If the wires are connected properly, the wire indicator light will be on.
3. Next, turn on the receiver by turning the Stimulation Selection Dial on the receiver to the desired level. The LED light will blink once every two seconds showing that it is on.  
\* If not activated for 10 seconds or more, the system will go into sleep mode.
4. Hold the receiver in your hand with the contact points facing up. Place the test lamp over the contact points and approach the test loop.
5. Watch for the test lamp to come on and the unit to vibrate. Be careful not to touch the contact points as the unit will emit stimulation when activated.



# INSTALLATION

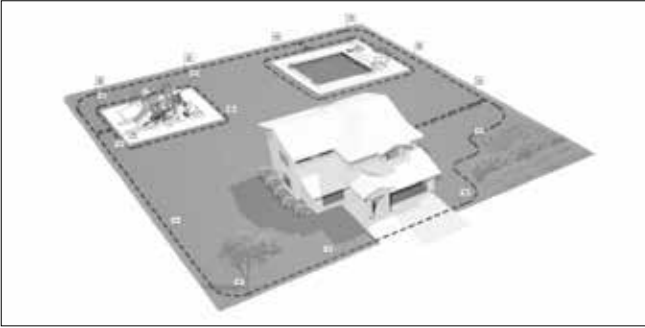

## **Fence Wire**

The e-fence boundary wire must make a continuous loop around your property for the system to operate. The signal is delivered from the terminal of the transmitter, through the fence wire, back to the other terminal on the transmitter. When this is accomplished, the wire continuity light will emit a constant red indicator.

## Common Boundary Designs

\*The diagrams below are indicated for a rectangular layout.

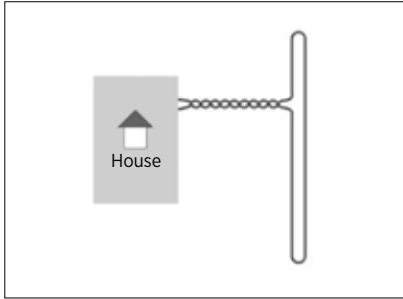

Front Boundary Only

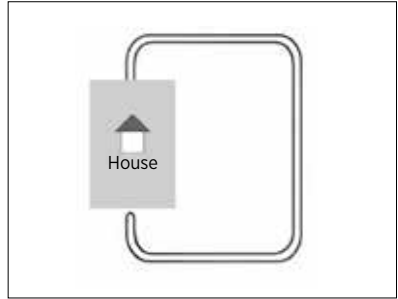

Fence Front Yard Only

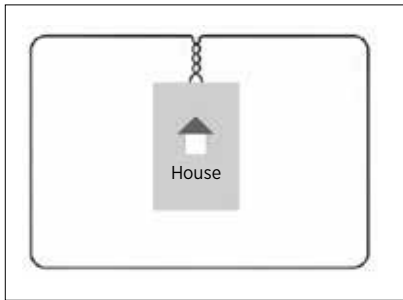

Front or Back Access

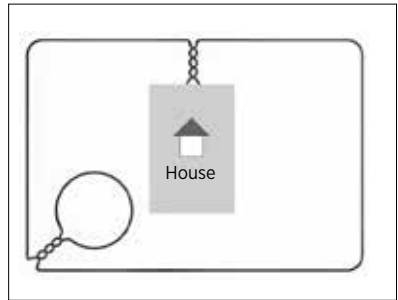

Basic Loop with Garden

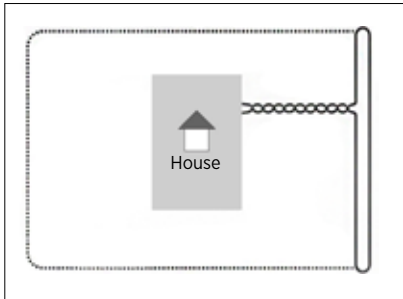

Front Boundary with Existing Fence

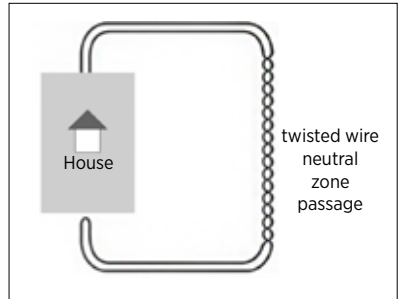

Double Loop with Passage

**CAUTION**

Before you install your E-FENCE 3500 wire, contact the utility company to mark the utility lines on your property before you begin digging. **Be sure to test your wire layout above ground before permanent installation begins.**

Carefully choose the areas in which you want to contain your dog. A diagram may be helpful in predicting unforeseen obstacles. (Please refer to the Common Boundary Designs)

**IMPORTANT**

When creating a Front Boundary Only, Fence Front Yard Only, or Front Boundary with Existing Fence type of containment system a double loop layout is required. The two parallel wires of the double loop must be 6-10 feet apart to avoid any signal interference. Single loop systems must also be kept 6-10 feet of distance between the wires as well.

**\* Please note the diagrams are not drawn to scale.**

The E-FENCE 3500 system includes 500 feet of boundary wire and 50 training flags. Additional flags and wiring can be purchased through the Dogtra Company. The estimated requirements are as follows:

Acres	Square Feet	Fence Wire(500ft./spool)		Flags(50/bundle)	
		Feet	#Spools	#Flags	#Bundles
1/4	10,890	450	1	45	1
1/3	14,520	520	1	52	1
1/2	21,780	620	2	62	2
3/4	32,670	740	2	74	2
1	43,560	850	2	85	2
2	87,120	1,200	3	120	3
3	130,680	1,500	3	150	3
4	174,240	1,700	4	170	4v
5	217,800	1,900	4	190	4
6	261,360	2,100	5	210	5
7	304,920	2,250	5	225	5
8	348,480	2,400	5	240	5
9	392,040	2,550	6	255	6
10	435,600	2,700	6	270	6
11	479,160	2,800	6	280	6
12	522,720	2,950	6	295	6
13	566,280	3,050	7	305	7
14	609,840	3,170	7	317	7
15	653,400	3,280	7	328	7
16	696,960	3,400	7	340	7
17	740,520	3,500	7	350	7
18	784,080	3,600	8	360	8
19	827,640	3,700	8	370	8
20	871,200	3,800	8	380	8

## Additional Parts

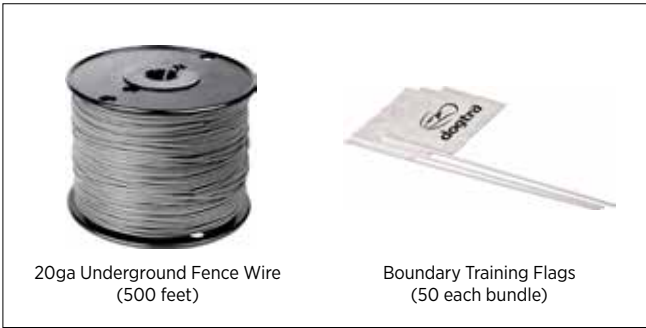

Actual flag/wire requirements may vary depending on the layout you've chosen. You will want to keep a signal field (area where the dog will receive stimulation) at least 6-8 feet on each side of the wire.

In addition, your dog will keep 2-4 feet away from the signal field, so an overall signal field of 8-12 feet is preferred. Avoid making passageways that are too narrow (i.e. along the sides on a house) or your dog may hesitate from using them.

## Tools

To install your E-FENCE 3500, you will need a flat-edge spade, Phillips screwdriver, and a wire cutter/stripper. If your layout calls for the wires to be connected across concrete, you will also need a caulking gun, exterior silicon caulk and a circular saw with a masonry blade for cutting the pavement.

## Creating a Neutral Zone in the Boundary

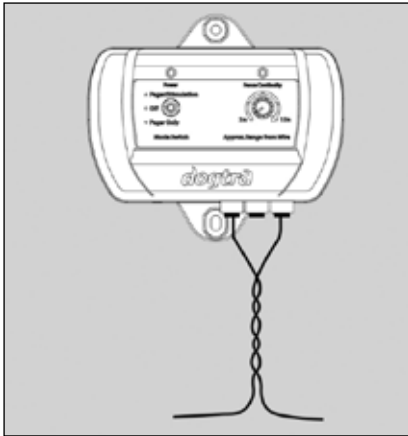

You must create a neutral zone from the fence transmitter to the beginning of the fence so the signals do not cross over to any existing utility wires. Start by twisting the two pieces of fence wire so they are braided from the beginning of the neutral zone area to the end. Braiding the two wires will interrupt the signal of the buried fence, thus creating an area for your dog to cross without getting stimulation. To braid the fence wire, hold the two wires side by side, and twist them around each other. This can also be done by securing the two

wire ends in the opening of a drill and letting the drill twist the wires for you. The tighter the wires are twisted, the better the signal cancellation. **Braiding the two wires will interrupt the signal of the boundary wire, thus creating a neutral zone.**

## Burying the Fence Wire

### IMPORTANT

Before starting any digging, contact your local phone, gas and power companies to locate any other buried services. The E-FENCE 3500 boundary wire does not have to be buried to operate. For protective measures we highly recommend the wire be buried about 3-4 inches underground. Begin by digging a 4-inch deep cut where the wire first enters the ground near the transmitter and continue around the path of the loop wire. A 30 to 45 degree angle cut made with a flat-edge spade will be easiest to close.

**Note:** When covering a large area, a trenching machine may be used to cut into the ground. However, it is recommended that the wire be placed in the trench by hand. A commercial wire-placing machine may damage the wire.

## **IMPORTANT**

**Bury the fence wire after you have tested the system** and are sure it is working properly. Do not nick or scrape the fence wire during installation as it may result in an intermittent signal or no signal. Make gradual turns at the corners with a radius of at least 3 feet. This will provide a more consistent signal field that will avoid confusing the dog in these areas.

**Do not** run the e-fence boundary wire within 6 feet parallel to electrical, telephone, cable TV or other buried wires.

**Do not** run the e-fence boundary wire of one section within 10 feet of another section of e-fence wire or the signal may cancel.

**Do not** run the e-fence boundary wire within 10 feet of a neighboring pet containment system boundary wire.

## **Driveways/Sidewalks**

When crossing an asphalt driveway, make a 1/2-inch deep cut across the driveway using a circular saw and masonry blade. Close the crack with asphalt sealant after the fence wire is placed in it. If an expansion joint is available on driveway and sidewalks, place e-fence wire in the joint and close it with outdoor caulk. When crossing gravel, bury fence wire at least 3 inches deep. PVC pipes or a garden hose can be used to protect the wire. In water, anchor the wire with large rocks. Use PVC piping or garden hose to protect the wire.

# WIRE SPLICING

The wire connection must be waterproof.

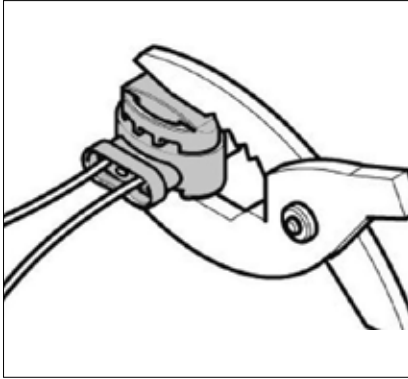

Do not use electrical tape, or soldered/twisted wire nuts in this type of connection as it will cause an intermittent signal or disarm the system.

The waterproof splices included in the E-FENCE 3500 system are designed to provide a sealed connection between the wires. The insulation on the boundary wire should not be stripped before placing wire into the holes.

To use the waterproof splices, boundary wire is placed into the outer holes of the

splices. This should leave the center hole empty. A pair of pliers should be used to gently press down and snap together the top of the blue part of the splice.

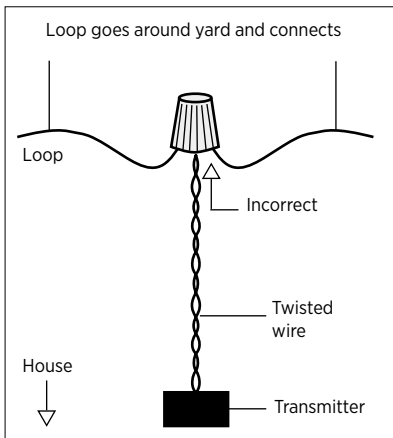

Incorrect Neutral Zone Wire Splicing

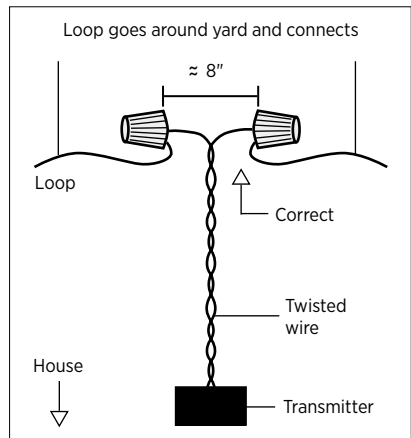

Correct Neutral Zone Wire Splicing

## Connecting the Fence Wire to the Transmitter

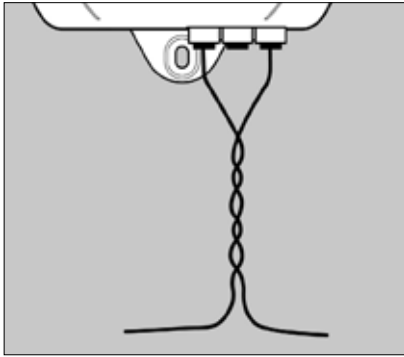

Splice the two ends of the twisted wire to each of the two ends of the fence wire. Drill a hole through the exterior wall or window/door sill or run the fence wire through an existing utility line hole. Connect the twisted fence wire to the transmitter, either wire to either terminal (wire ends must be stripped  $\frac{1}{2}$  inch), and a red indicator light should appear indicating a continuous fence wire field. If no light appears, check to make sure that all

fence wires are properly connected and that the wire is not damaged.

## The Signal Field

The Field Width Adjustment Knob on the transmitter controls the signal field width. Increasing or decreasing the signal field width does not affect the stimulation intensity. To test the signal field, walk slowly toward the boundary wire holding the receiver at approximately the height of the dog's neck. The contact points must be upward with the test light attached. Watch for the test lamp to illuminate as this will give you an idea of the width of the signal field. The most common and desirable signal strength will be found by setting the system in the green/yellow zone, which creates a 2ft - 6ft signal area.

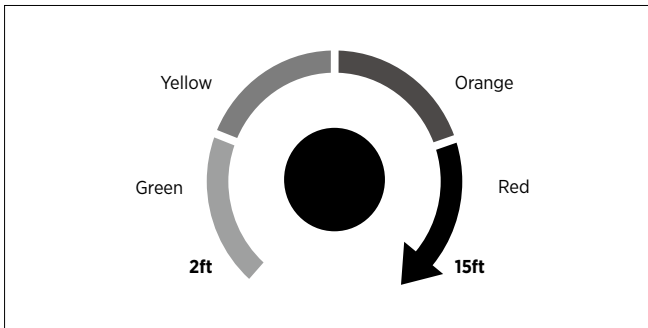

Field Width Adjustment Knob



## OPTIONAL ACCESSORIES

The following items may be purchased separately. To purchase accessories, please visit Dogtra's online store at [www.dogtra.com](http://www.dogtra.com) or call customer service at (888) 811-9111.

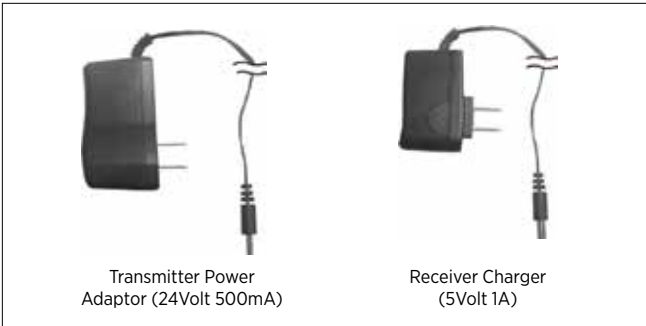

- European Adaptor for 220-volt outlets



- Lightning/Surge Protector (PANAMAX)

## Connecting a Lightning Surge Protector

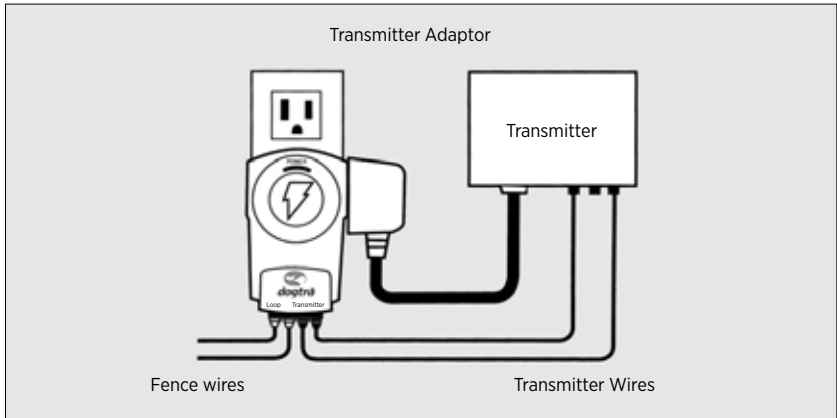

Plug the lightning protector into a grounded (3-wire) 120V AC outlet within five feet of where you want to locate the transmitter. Cut the e-fence wires near the protector and strip all four ends back  $\frac{1}{4}$  inch. Push the connector tab firmly away from yourself and the connector jaws will open. Push the stripped end of the wire into the connector.

# TROUBLESHOOTING GUIDE

## 1. My dog is not reacting to the receiver.

- Make sure the receiver and transmitter are turned on.
- Make sure the collar strap is tight enough so both contact points are touching the dog's skin.
- The contact points may be too short for the dog. To place an order for longer contact points that are more appropriate for your dog, please call (888) 811-9111. If you are already using the longest contact points available, you might need to trim down the hair on the dog's neck so both contact points are touching the dog's skin.
- The intensity level may be too low for your dog. Keep increasing the stimulation until the dog responds, usually with neck movement, head shaking, looking over its shoulder, etc. (response may be very subtle).

## 2. System Test Procedures:

Whenever you experience a malfunction, you will need to do a test loop to determine which component - receiver, wall transmitter, or yard wire - is not working. Follow these steps to perform the test loop procedure.

1. Make a test e-fence using at least 10 ft. to 20 ft. of fencing wire (or use the ground wire).
2. Remove the existing boundary wire from your wall transmitter.
3. Insert the two ends of the test e-fence wire into the wall transmitter.
4. Turn the field width adjustment knob to the 9 o'clock position or a low setting.
5. Place the test light on the receiver. With the receiver, approach the test loop and note the distance between you and the wire when the collar activates the test lamp.
6. Turn the field width adjustment knob to the 12 o'clock position or a medium setting.
7. Back away from the wire and approach it again. Determine the distance between you and the wire when the collar activates. The distance should be greater on the medium range setting.

If more than one receiver is used, repeat the above test on each collar. If there is no red light on the wire indicator light of the wall transmitter with the test loop wire in place, the wall transmitter is malfunctioning. If the red light is solid on the wall transmitter, but the collar does not activate on the test loop wire, the receiver not working. Recharge the battery in the receiver and repeat the test. If the collars are activating normally, there may be a wire break in the fence wire.

## **Finding a wire break using an Underground Cable Wire Locator\***

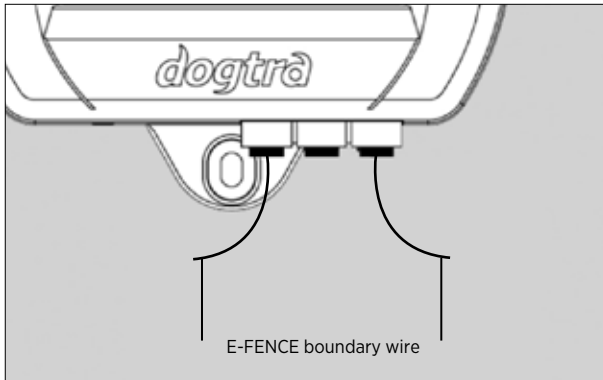

1. Go to the E-FENCE 3500 wall-mounted transmitter and disconnect the two boundary wire leads from the red connector tabs.
  2. Get the Underground Cable Wire Locator transmitter:
    - Connect the red alligator clip to the end of one of the E-FENCE 3500 boundary wires.
    - Connect the black alligator clip to the end of the ground wire that is not in the ground.
  3. Turn the Underground Cable Wire Locator transmitter from “OFF” to “Cable Scan” and leave the transmitter connected to the wires.
  4. Get the Underground Cable Wire Locator receiver and walk slowly along the path of the boundary wire. You should hear a whirling/static noise where the boundary wire is intact and no whirling noise where the break is located.
- \* Instructions based on the Noyafa NF-816-C Underground Cable Wire Locator. Other similar Underground Cable Wire Locators can be used as well to detect the breakage. However, the instructions may vary based on the Underground Cable Wire Locator used.

### **Fixing the Break**

Once you have found the break, cut out the damaged area and use a weatherproof gel style wire splicer to reconnect the wires. If the break is large, or if you cannot identify the break location, you may need to splice in some extra wire to bypass the area that is damaged.

## GENERAL MAINTENANCE TIPS

Your system requires very little maintenance. The receiver for the E-FENCE 3500 system is fully waterproof. To remove dirt, simply wipe with soap and water. The wall transmitter is not waterproof and must be protected from the elements in a shed, garage or carport. Do not attempt to dismantle or repair the wall mount transmitter or receiver as : this will void the manufacturer's warranty. These components contain computerized circuitry that should be serviced only by an authorized expert.

### **Caution**

Any changes or modifications of this device which are not specifically approved by the party responsible for compliance could void the user's authority to operate the equipment.

# DOGTRA PRODUCT WARRANTY

## LIMITED WARRANTY

### For Dogtra Products Purchased from Dogtra Authorized Dealers

#### One-Year Warranty

Except as otherwise provided below, Dogtra warrants to the original retail purchaser ("You") that its Dogtra products shall be free of defects in materials and workmanship for a period of one (1) year from the date of purchase ("Warranty"). The Warranty covers the cost of repair (parts and labor) or replacement (if repair is not feasible) of a defective Dogtra product during said one-year period. For such repaired or replaced products, the remaining portion of the original warranty period, or ninety (90) days, whichever is longer, shall apply. Dogtra, at its sole discretion, shall determine whether to repair or replace a product covered by the Warranty.

#### Warranty Conditions

The Warranty is not transferrable and applies to your Dogtra product only if:

- (1) You are the original retail purchaser of the product,
- (2) You bought the product from a Dogtra authorized dealer, and
- (3) You present a receipt or other proof of purchase showing a valid purchase date, the name and address of the authorized dealer, and the purchased product identified by model and/or serial number.

#### Warranty Exclusions

The Warranty does not cover damage, loss, or deterioration to your Dogtra product caused: by misuse, neglect, abuse, or other improper handling of the product; by failure to follow use or care instructions; by use of the product for other than its intended purpose; by accident or natural forces such as fire or flooding; or by normal wear and tear such as scratches to the product surface.

The Warranty also does not cover Dogtra products that: are purchased from non-authorized dealers; are purchased outside of the United States or Canada; have been damaged during shipment (even if Dogtra paid or arranged for shipping); have been modified or tampered with in any manner; are opened or repaired by anyone other than Dogtra; or have serial numbers that have been altered or defaced.

#### Sole Warranty

This Warranty is the only warranty offered by Dogtra for its Dogtra products. Other than said Warranty, Dogtra makes no other representations or warranties whatsoever regarding its products, whether oral or in any product manual, on any packaging, on any website, or in any other written material. No dealer of Dogtra products, nor any employee or agent of Dogtra, is authorized to make any additions, changes, or extensions to the Warranty. Dogtra, at its sole discretion and at any time, reserves the right to modify the Warranty.

#### DISCLAIMER OF OTHER WARRANTIES

**THE FOREGOING WARRANTY IS PROVIDED IN LIEU OF ALL OTHER WARRANTIES, WHETHER EXPRESS OR IMPLIED. DOGTRA DISCLAIMS ANY IMPLIED WARRANTIES INCLUDING, BUT NOT LIMITED TO, THE IMPLIED WARRANTIES OF MERCHANTABILITY AND FITNESS FOR A PARTICULAR PURPOSE.**

#### Limitation of Remedies

Dogtra's liability is limited to the cost of repair or replacement of the Dogtra product under Warranty. Any claim or action to enforce the Warranty must be commenced within thirty (30) days of the Warranty's expiration for your product. Dogtra will not be liable for any indirect, incidental, special, consequential, or similar damages based on breach of warranty, breach of contract, negligence, strict tort, or any other legal theory related to Dogtra and its products. Damages that Dogtra will not be responsible for include, but are not limited to: loss of income or profits; loss of revenue or savings; loss of use of the product or associated products; cost of any substitute products or services; inconvenience, downtime, or any other time; loss of goodwill; claims of third parties including customers; and damage to property.

#### Legal Rights May Vary By State or Jurisdiction

The Warranty gives You specific legal rights, and You may also have other rights which vary by state or jurisdiction. Some states or jurisdictions do not allow certain limitations of implied warranties or of incidental or consequential damages or other remedies, so certain of the foregoing limitations may not apply to You.

If any portion of the Warranty is held by a court to be invalid or unenforceable, the remaining portions of the Warranty shall remain in full force and effect and shall in no way be affected or invalidated, and the invalid or unenforceable portion shall be modified so as to most nearly achieve the intent of the Warranty.

#### Product Registration

Dogtra recommends that customers register their products as soon as possible after purchase. Product registration will facilitate any future warranty service. You may also receive useful information and updates about your existing and future Dogtra products. To register your product, visit [www.dogtra.com/product-registration](http://www.dogtra.com/product-registration). If your product is not registered with Dogtra, You will be required to provide a receipt or other proof purchase (as provided above) to qualify for warranty service.

**How to Obtain Warranty Service**

Should your Dogtra product require warranty service, please contact Customer Service by phone or email for a warranty evaluation (see below for contact information). Upon approval of your warranty work, Dogtra will repair or replace (at Dogtra's election) your product without charge for labor or parts. You are responsible for shipping, including cost, of your product to Dogtra for warranty service. Dogtra will handle shipping, including cost, of the repaired or replaced product back to customers in the USA. Dogtra will not be responsible for shipping, including cost and/or applicable taxes or fees, for products sent to Canada. Such costs, taxes, or fees will be borne by the customer.

To register your product, visit [www.dogtra.com/product-registration](http://www.dogtra.com/product-registration).

**Dogtra Customer Service**

12322 Monarch Street, Garden Grove, CA 92841  
(888) 811-9111  
repair@dogtra.com  
Mon – Fri, 8:00 AM to 4:30 PM (PST)

© 2021 Dogtra. All rights reserved.